

This drawing is for webpage display only !

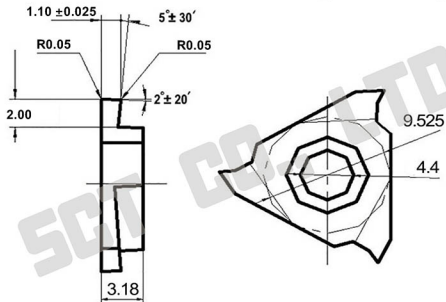

B20 <input type="checkbox"/> Free Cutting Steel	B09 <input type="checkbox"/> Cast Iron	B00 <input type="checkbox"/> Aluminium / Bronze	GBA Grooving Insert	Part Number	GBA32R110-005 <input type="checkbox"/> GBA32L110-005 <input type="checkbox"/>
H10 <input type="checkbox"/> Stainless Steel	Right Hand <input type="checkbox"/> Left Hand <input type="checkbox"/>	Notes	SPECIAL CUTTING TOOLS CO., LTD. 		
			www.special-cutting-tools.com		