

This drawing is for webpage display only !

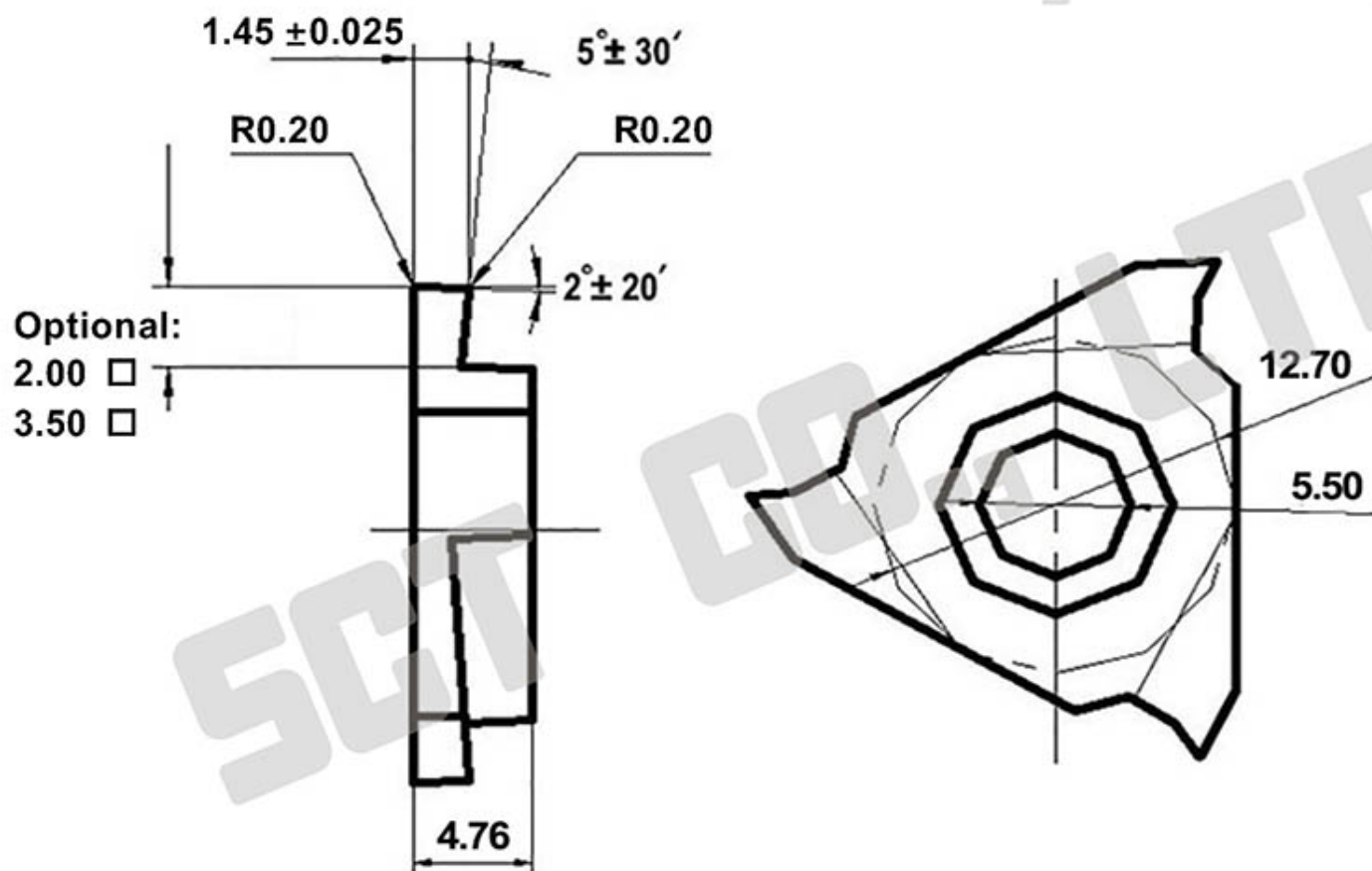

B20 <input type="checkbox"/> Free Cutting Steel	B09 <input type="checkbox"/> Cast Iron	B00 <input type="checkbox"/> Aluminium / Bronze	GBA Grooving Insert	Part <a href="#">GBA43R145-020</a> <input type="checkbox"/> Number <a href="#">GBA43L145-020</a> <input type="checkbox"/>
H10 <input type="checkbox"/> Stainless Steel	Right Hand <input type="checkbox"/> Left Hand <input type="checkbox"/>	Notes	<b>SPECIAL CUTTING TOOLS CO., LTD.</b> <a href="http://www.special-cutting-tools.com">www.special-cutting-tools.com</a> 	