

This drawing is for webpage display only !

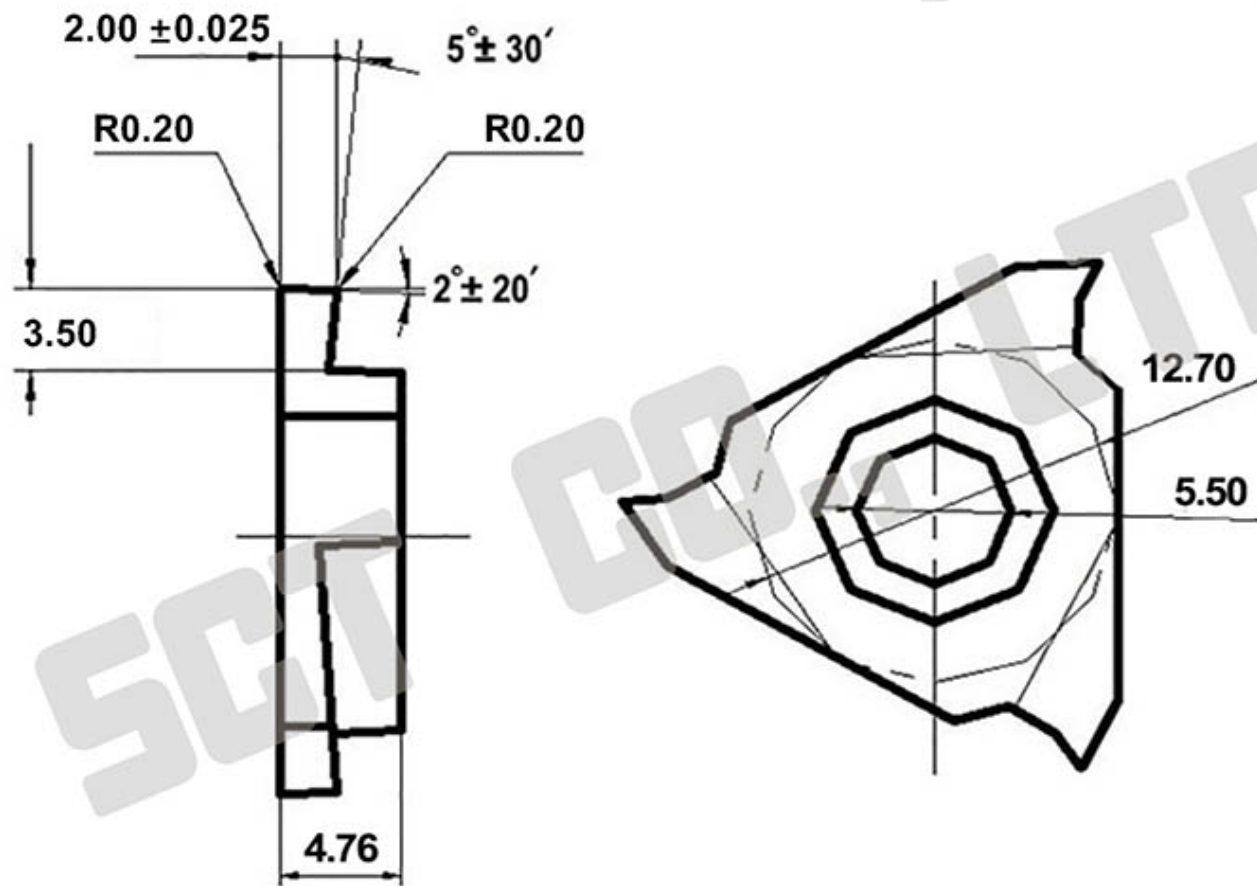

B20 <input type="checkbox"/> Free Cutting Steel	B09 <input type="checkbox"/> Cast Iron	B00 <input type="checkbox"/> Aluminium / Bronze	GBA Grooving Insert	Part <input type="checkbox"/> Number <input type="checkbox"/>	GBA43R200-020 GBA43L200-020
H10 <input type="checkbox"/> Stainless Steel	Right Hand <input type="checkbox"/> Left Hand <input type="checkbox"/>	Notes	SPECIAL CUTTING TOOLS CO., LTD. 		
			www.special-cutting-tools.com		